

Wahl Lithium•Ion® Shaver Quickstart Guide

1. Charge Unit

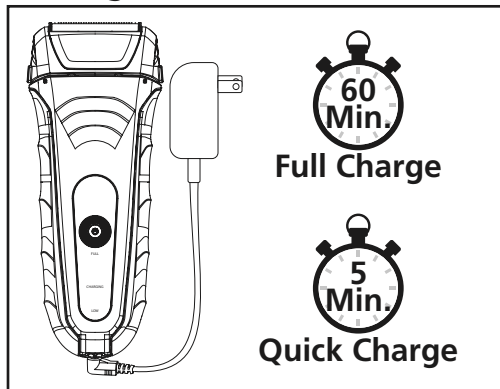

2. Disable/Enable Travel Lock

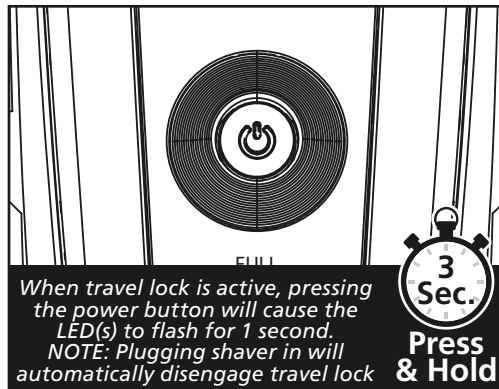

3. Pop-Up Trimmer for Long Hairs*

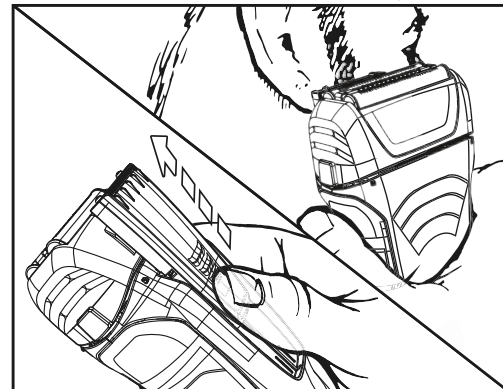

4. Clean Foils

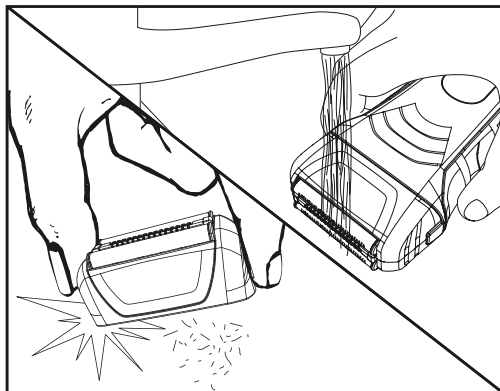

5. Use Brush to Clean Blades*

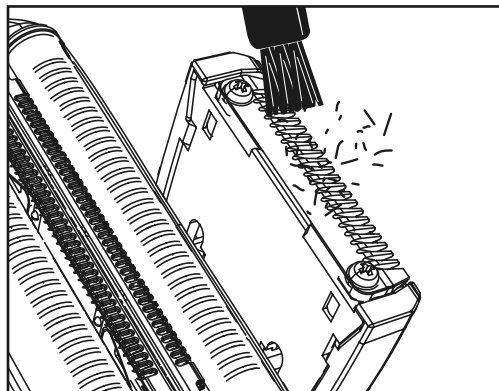

6. Store with Protective Foil Guard

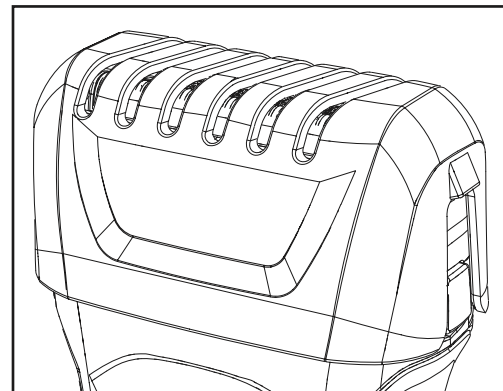

If you are a first-time electric shaver user, or changing from another brand, there will be a 2 to 3 week (or less) adjustment period while your face and beard adapts to the new foil.

*Pop-up trimmer not included on all models

Charging Your Wahl Lithium•Ion® Shaver

MODELS WITH 1 LED

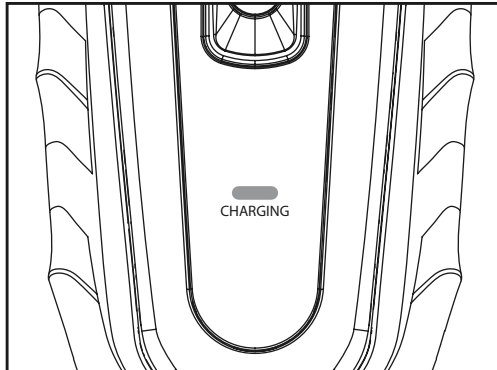

Charging

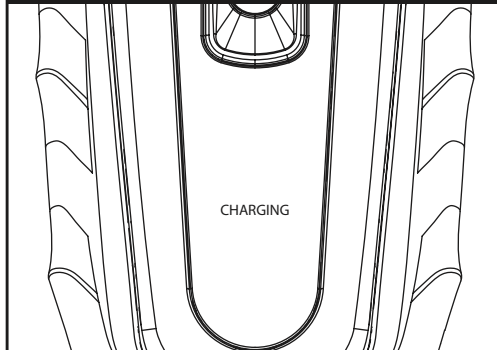

Charge Complete
LED shuts off

MODELS WITH 2 LEDs

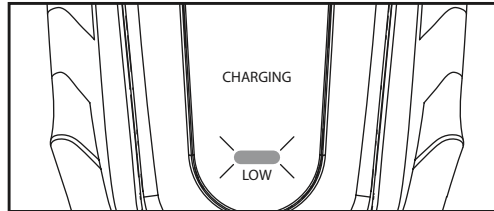

Needs to Be Charged
flashes for 1 second when turning off

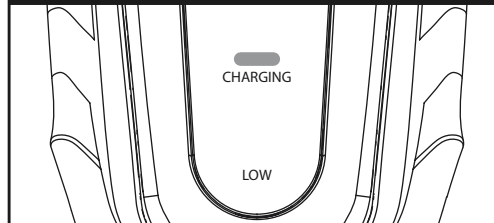

Charging

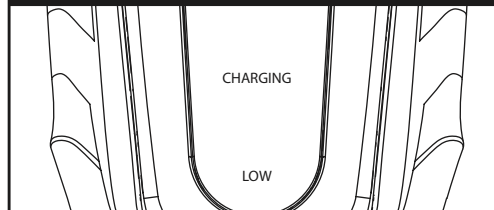

Charge Complete
LEDs shut off

MODELS WITH 5 LEDs

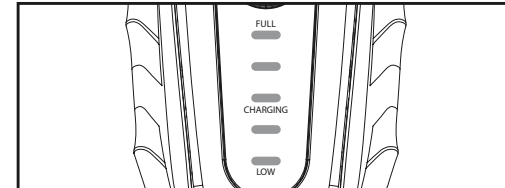

Charge Meter
shows amount of charge left
and progression when charging

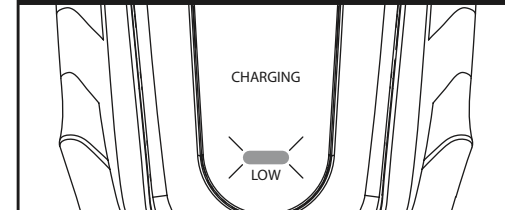

Needs to Be Charged
flashes for 1 second when turning off

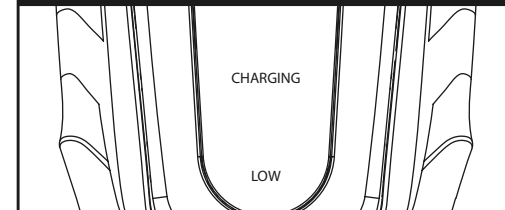

Charge Complete
LEDs shut off